

RoHS Compliant

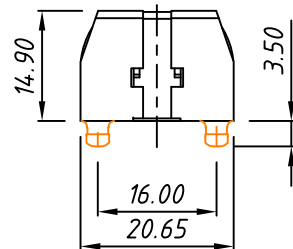

With Post

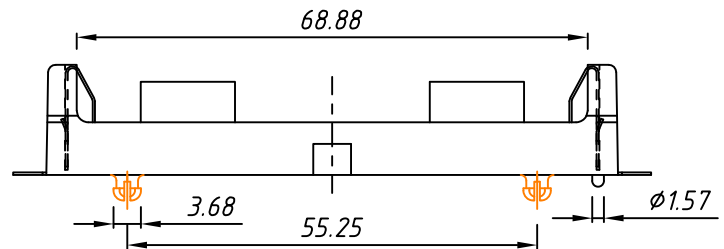
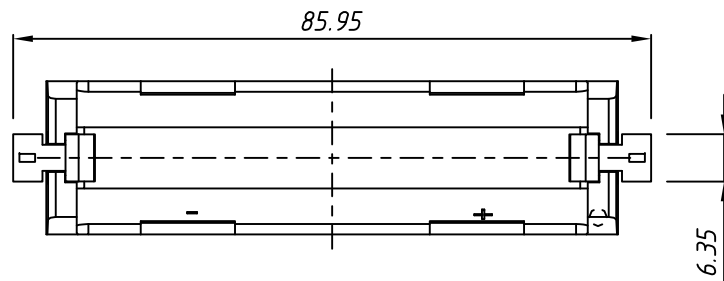
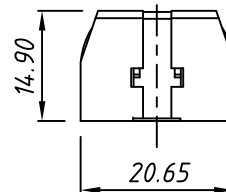

Without Post

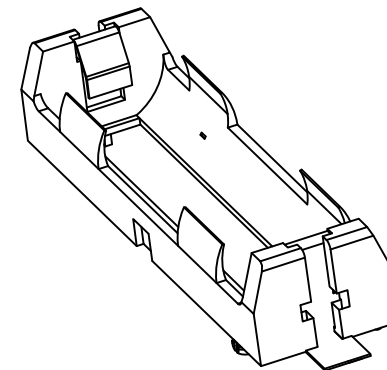

**MATERIAL**

Insulator: Nylon 66,Black,UL94V-0  
 Contact: 0.35 Phosphor Bronze,  
 Gold Plate

**ORDER INFORMATION:**

L - KLS5 - 18650 - 012 - M X

RoHS  
 1Li-ion 18650 Battery Holder  
 M: SMT Type  
 Post: 0- without Post  
 1- with Post

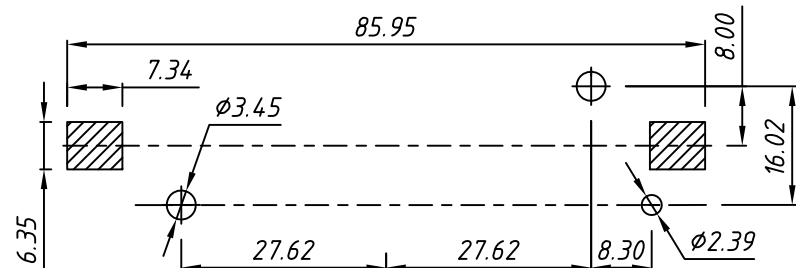
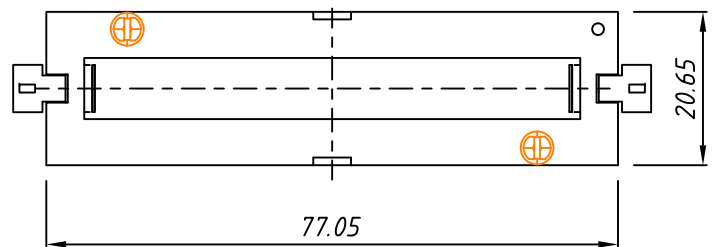

RECOMMENDED PCB LAYOUT  
 TOLERANCE: ±0.05

GENERAL TOLERANCE	±0.50	PROJECTION	Description: 1Li-ion 18650 Battery Holder, SMT Type
		UNITS	
Angle TOLERANCE	±3°	SHEET SIZE	A4
		KLS P/N: L-KLS5-18650-012-MX	
Draw:	Daniel	 NingBo KLS ELECTRONIC CO.,L TD.	
Check:	Daniel		
Data:	2019-03-08		